

VIEW BA
HYD SUSP LOWER SOLS
NO SCALE

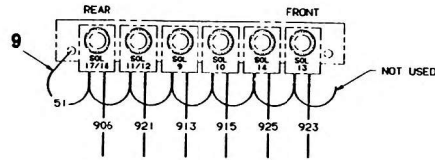

VIEW BB
REAR AIR SUSP SOLS
NO SCALE

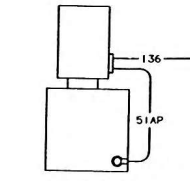
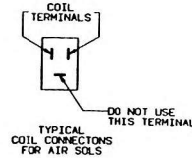

VIEW BC
TRANS OIL COOLER SOL
NO SCALE

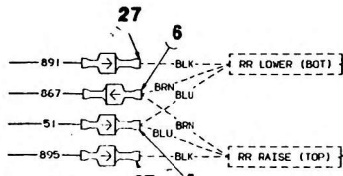

VIEW BD 27
RIGHT REAR PROXY SWS
NO SCALE

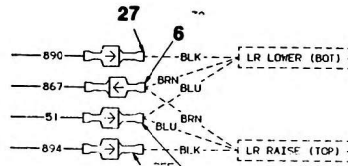

VIEW BE 27
LEFT REAR PROXY SWS
NO SCALE

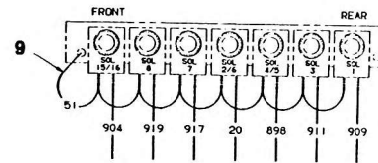

VIEW BF
FRONT AIR SUSP SOLS
SCALE 1:1

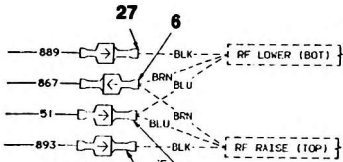

VIEW BG 27
RIGHT FRONT PROXY SWS
NO SCALE

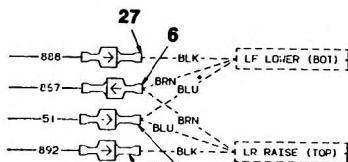

VIEW BH 27
LEFT FRONT PROXY SWS
NO SCALE

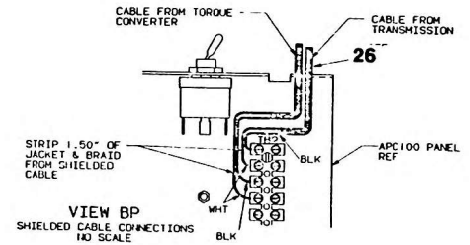

VIEW BP
SHIELDED CABLE CONNECTIONS
NO SCALE

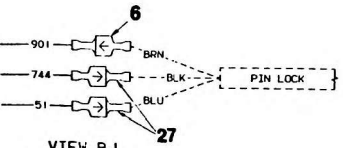

VIEW BJ
PIN LOCK PROXY SW
NO SCALE

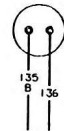

VIEW BL
TRANS OIL COOLER SW
NO SCALE

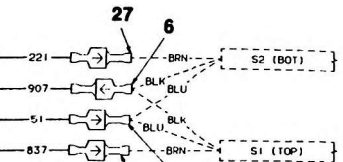

VIEW BK 27
REAR STEER LOCK PROXY SWS
NO SCALE

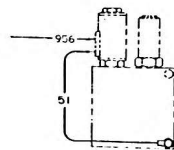

VIEW BR
O/R EXT PRESS REDUCING SOL
NO SCALE

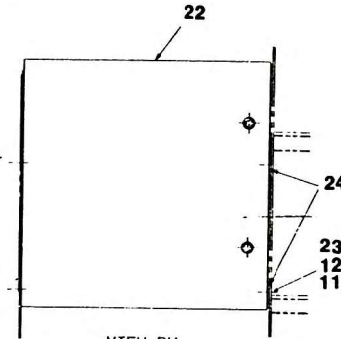

VIEW BM
CARRIER JUNCTION BOX
NO SCALE

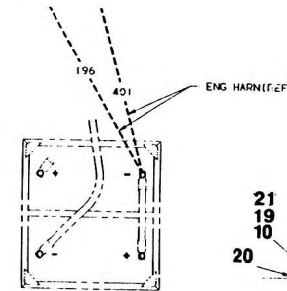

VIEW BN
BATTERY CONNECTIONS
SCALE NONE

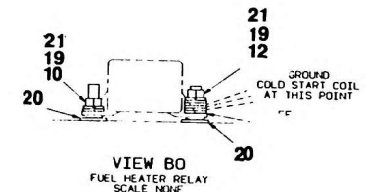

VIEW BO
FUEL HEATER RELAY
SCALE NONE

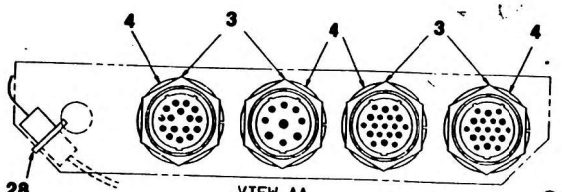

VIEW AA
CARRIER HARNESS CONNECTORS
SCALE 1:1

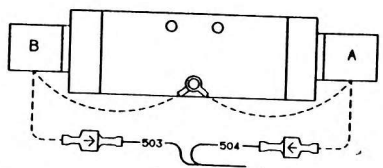

VIEW AC
TRANS RANGE SHIFT
SOLENOID
SCALE 1:1

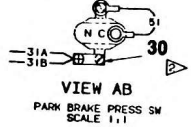

VIEW AB
PARK BRAKE PRESS SW
SCALE 1:1

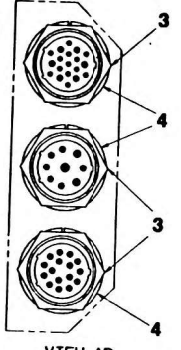

VIEW AD
SWIVEL HARNESS CONNECTORS
SCALE 1:1

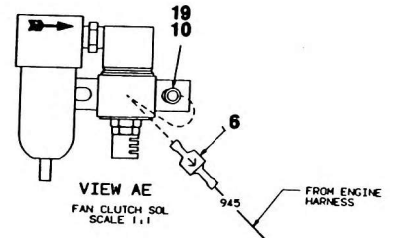

VIEW AE
FAN CLUTCH SOL
SCALE 1:1

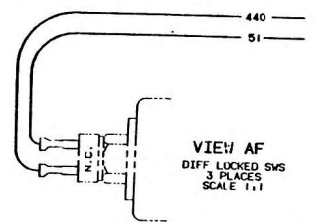

VIEW AF
DIFF LOCKED SWS
3 PLACES
SCALE 1:1

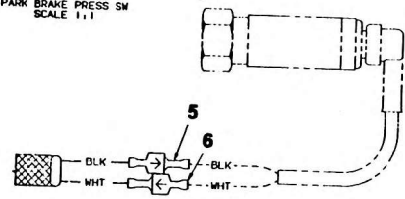

VIEW AG
TACHOGRAPH SENDER
SCALE 1:1

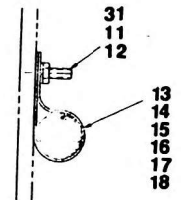

VIEW AK
TUBING CLAMPS
SCALE NONE

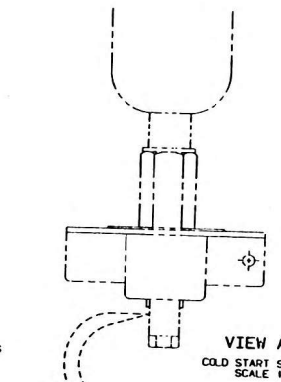

VIEW AL
COLD START SOLENOID
SCALE 1:1

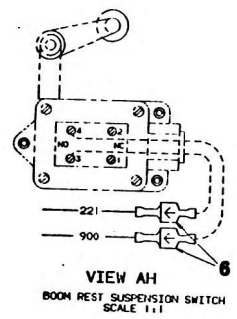

VIEW AH
BOOM REST SUSPENSION SWITCH
SCALE 1:1

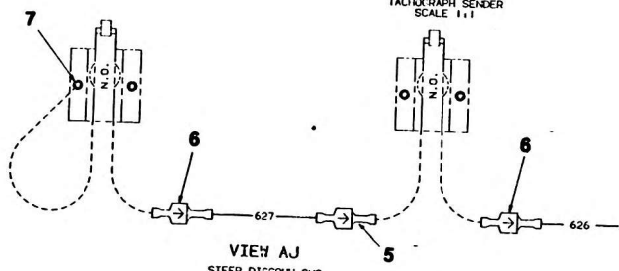

VIEW AJ
STEER DISCOON SWS
SCALE 1:1

INSTALL TUBING CLAMPS ITEMS #13-#17 & SECURE WITH ITEMS #11 & #12. INSTALL TUBING CLAMPS APPROX. 24" APART & 6" ON EACH SIDE OF ALL BREAKOUTS. ROUTE HARNESS & INSTALL CLAMPS SO HARNESS IS AT LEAST 1" FROM FUEL LINES & MOVING PARTS & AT LEAST 2" FROM EXHAUST PIPES.

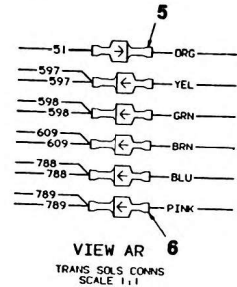
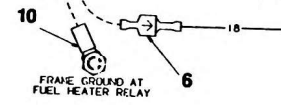

VIEW AR
TRANS SOLS CONNS
SCALE 1:1

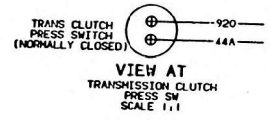

VIEW AT
TRANSMISSION CLUTCH
PRESS SW
SCALE 1:1

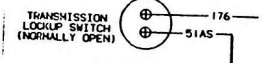

VIEW AM
TRANSMISSION LOCKUP
SOLENOID & SW
SCALE 1:1

NOTE: LOCKTITE ITEMS #30 TO TERMINAL SCREWS

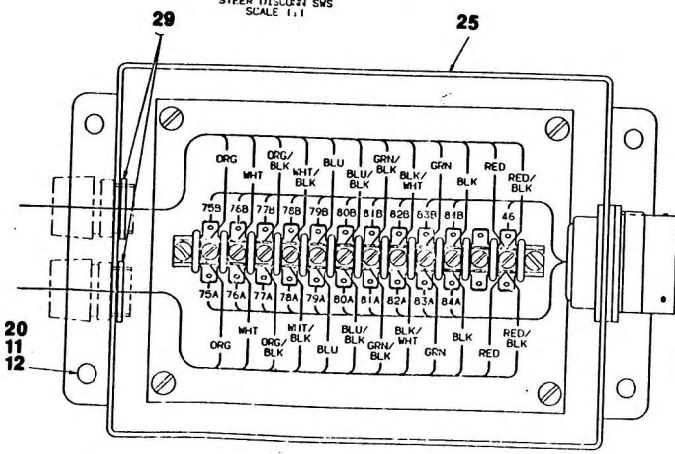

VIEW AN
O/R JCT BOX
SCALE 1:1

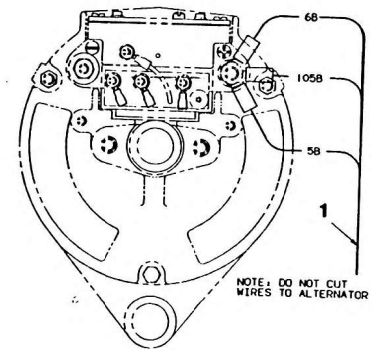

VIEW AP
ALTERNATOR
SCALE 1:1

NOTE: DO NOT CUT WIRES TO ALTERNATOR

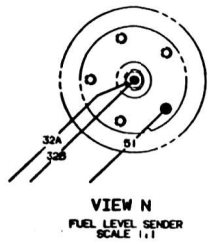

VIEW N
FUEL LEVEL SENDER
SCALE 1:1

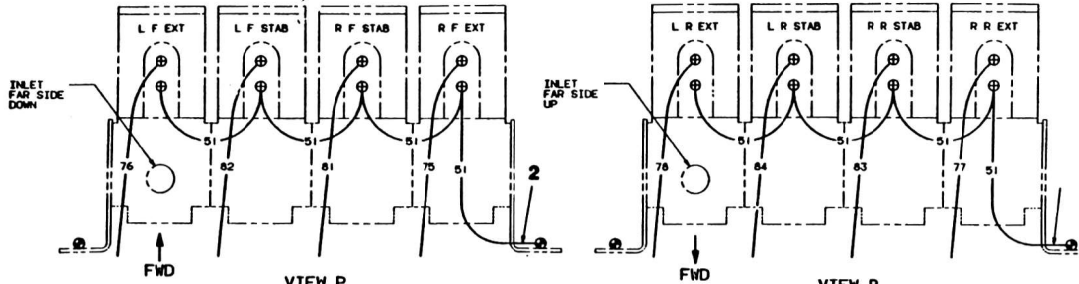

VIEW P
FRONT D/R SOLENOIDS
TOP VIEW
SCALE 1:1

VIEW R
REAR D/R SOLENOIDS
BOTTOM VIEW
SCALE 1:1

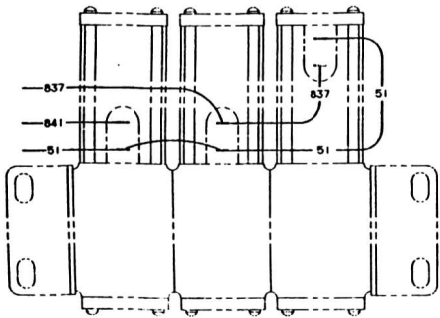

VIEW S
REAR STEER SOL
STEER PREVENT SOL
PRESS RELEASE SOL
SCALE 1:1

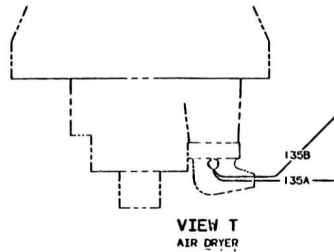

VIEW T
AIR DRYER

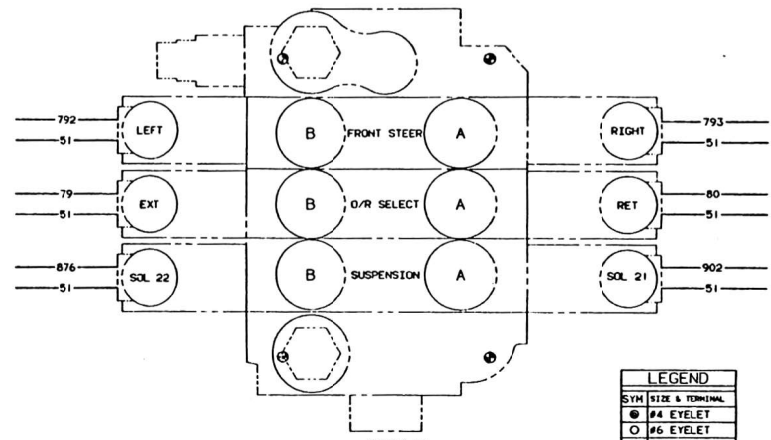

VIEW U
FRONT STEER SOLS
D/R SEL SOLS
SUSPENSION SOLS
SCALE 1:1

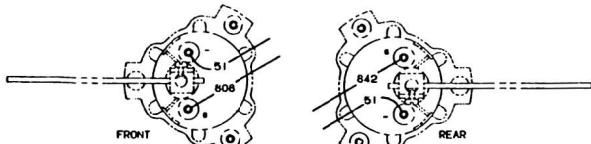

VIEW V
STEER INDICATORS
SCALE 1:1

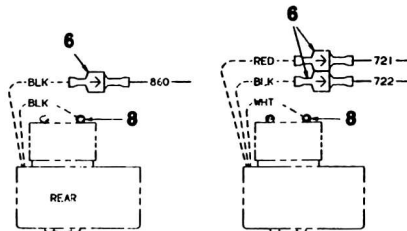

VIEW X
INTER AXLE
DIFF LOCK SOL
SCALE 1:1

VIEW Y
STEERLOCK SOL
SCALE 1:1

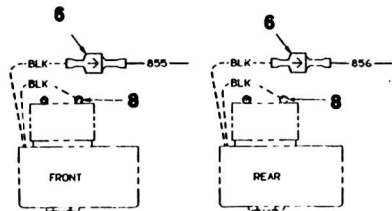

VIEW W
CROSS AXLE
DIFF LOCK SOLS
SCALE 1:1

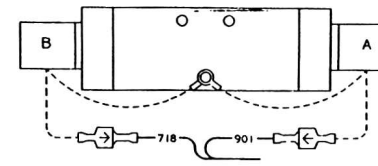

VIEW Z
PARK BRAKE MODE SOLS
SCALE 1:1

LEGEND	
SYM	SIZE & TERMINAL
●	#4 EYELET
○	#6 EYELET
○	#8 EYELET
○	#10 EYELET
○	1/4 EYELET
○	5/16 EYELET
○	3/8 EYELET
○	7/16 EYELET
○	1/2 EYELET
⊕	1/4 FASTON
⊕	3/16 FASTON
⊕	5/16 FASTON
⊕	PIGTAIL
□	10A PIN & RECEPT
□	180 PIN & RECEPT
⊞	WIRE NUT
⊞	SPLICE
⊞	WHITE DISCONNECT
⊞	PIN GRIP
→	MALE PIN
←	FEMALE RECEPT
⊞	BATT POST CLAMP

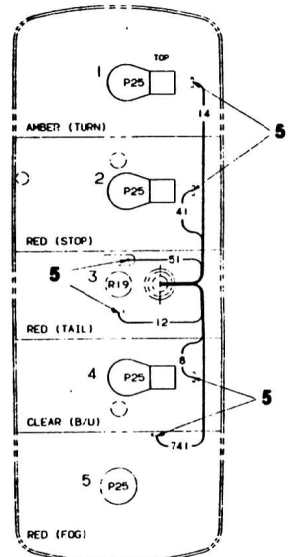

REAR VIEW C
RIGHT REAR COMBO LIGHT
STOP, TURN, TAIL,
FOG & BACK-UP
SCALE 1:1

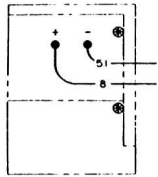

VIEW K
BACK-UP ALARM
SCALE 1:1

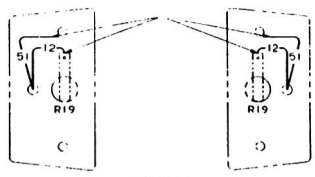

VIEW L
LICENSE LIGHTS
SCALE 1:1

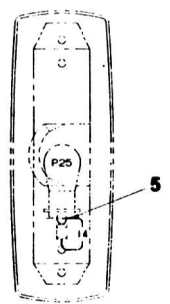

VIEW D
RIGHT TURN SIGNAL
SCALE 1:1

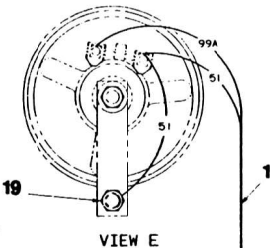

VIEW E
HORN
SCALE 1:1

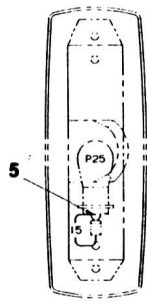

VIEW F
LEFT TURN SIGNAL
SCALE 1:1

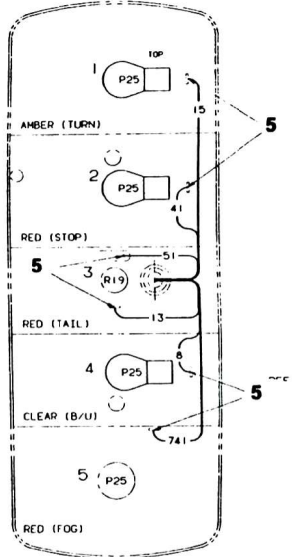

REAR VIEW H
LEFT REAR COMBO LIGHT
STOP, TURN, TAIL,
FOG & BACK-UP
SCALE 1:1

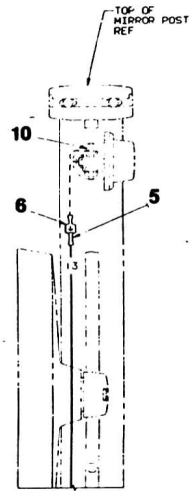

VIEW J
OPT MARKER LIGHT
SCALE 1:2

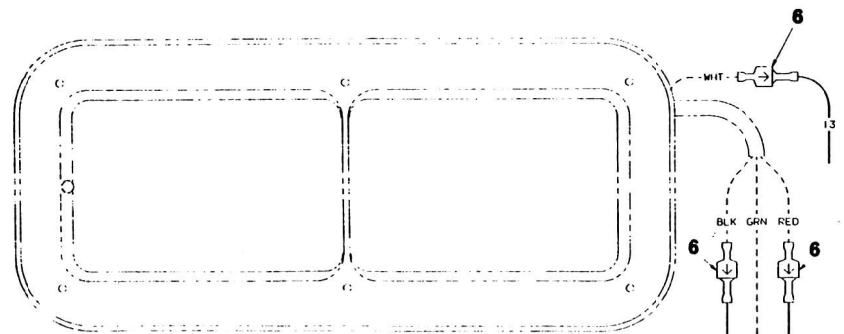

VIEW A
RIGHT FRONT HEAD LIGHT
SCALE 1:1

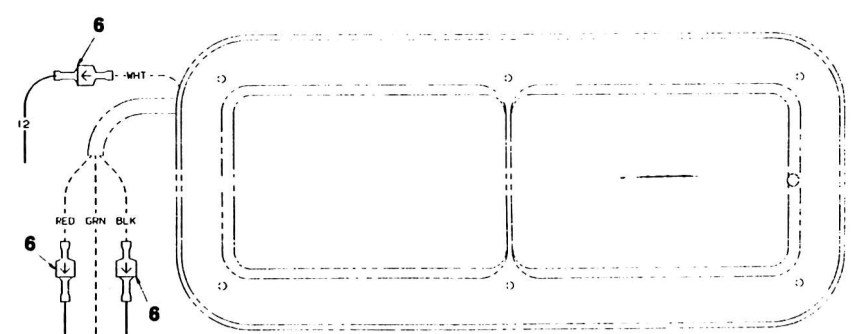

VIEW B
LEFT FRONT HEAD LIGHT
SCALE 1:1

NOTE: WIRES FROM THE HEADLIGHTS MUST BE CUT TO PROPER LENGTH AT ASSEMBLY BEFORE ITEMS #6 & #10 ARE INSTALLED

10

10

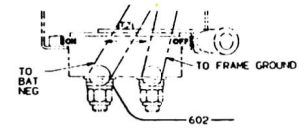

VIEW M
BATTERY DISCONNECT SW
SCALE 1:1

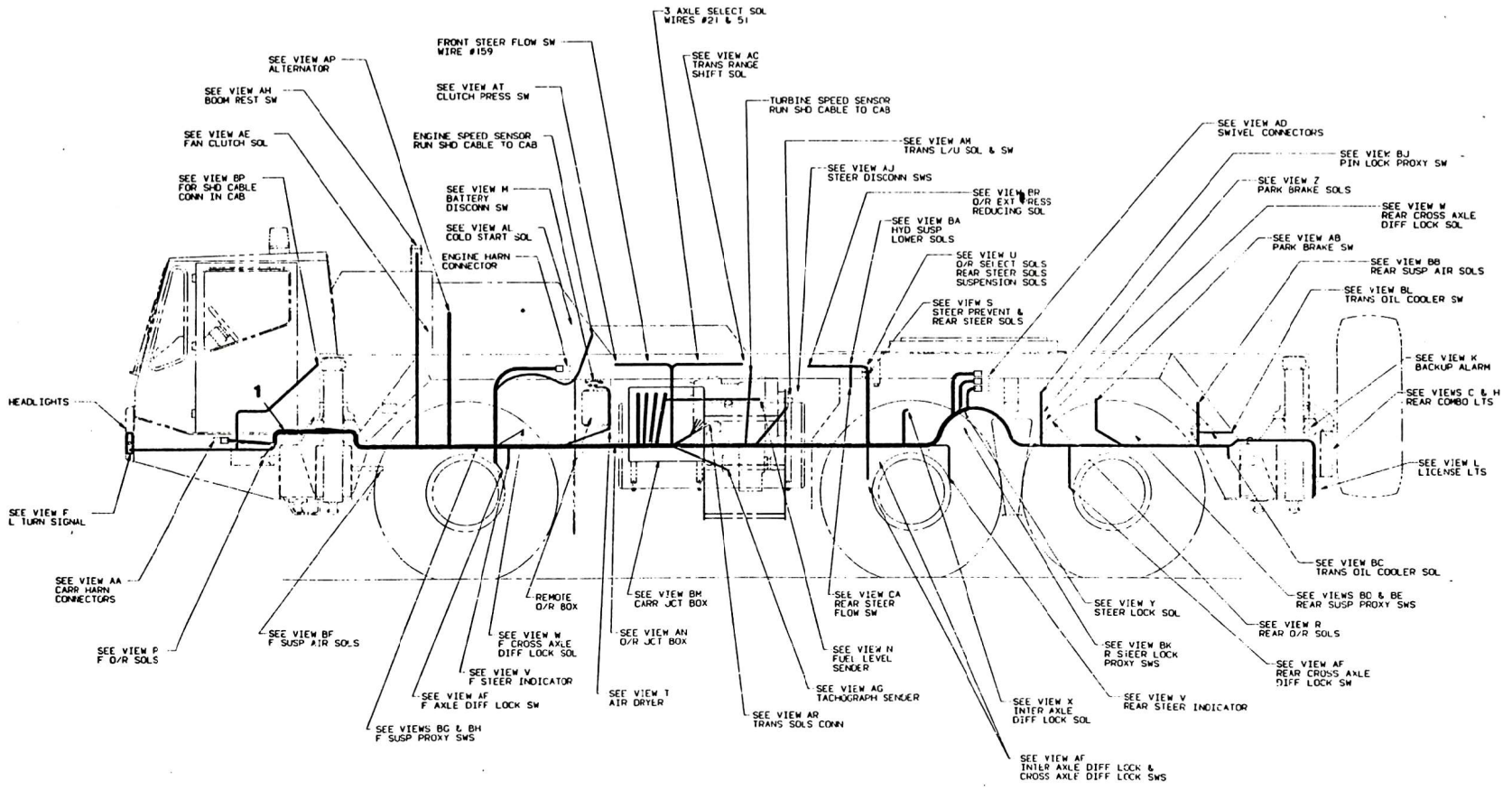

SHEET 2 OF 6

6-978-003001

GROVE

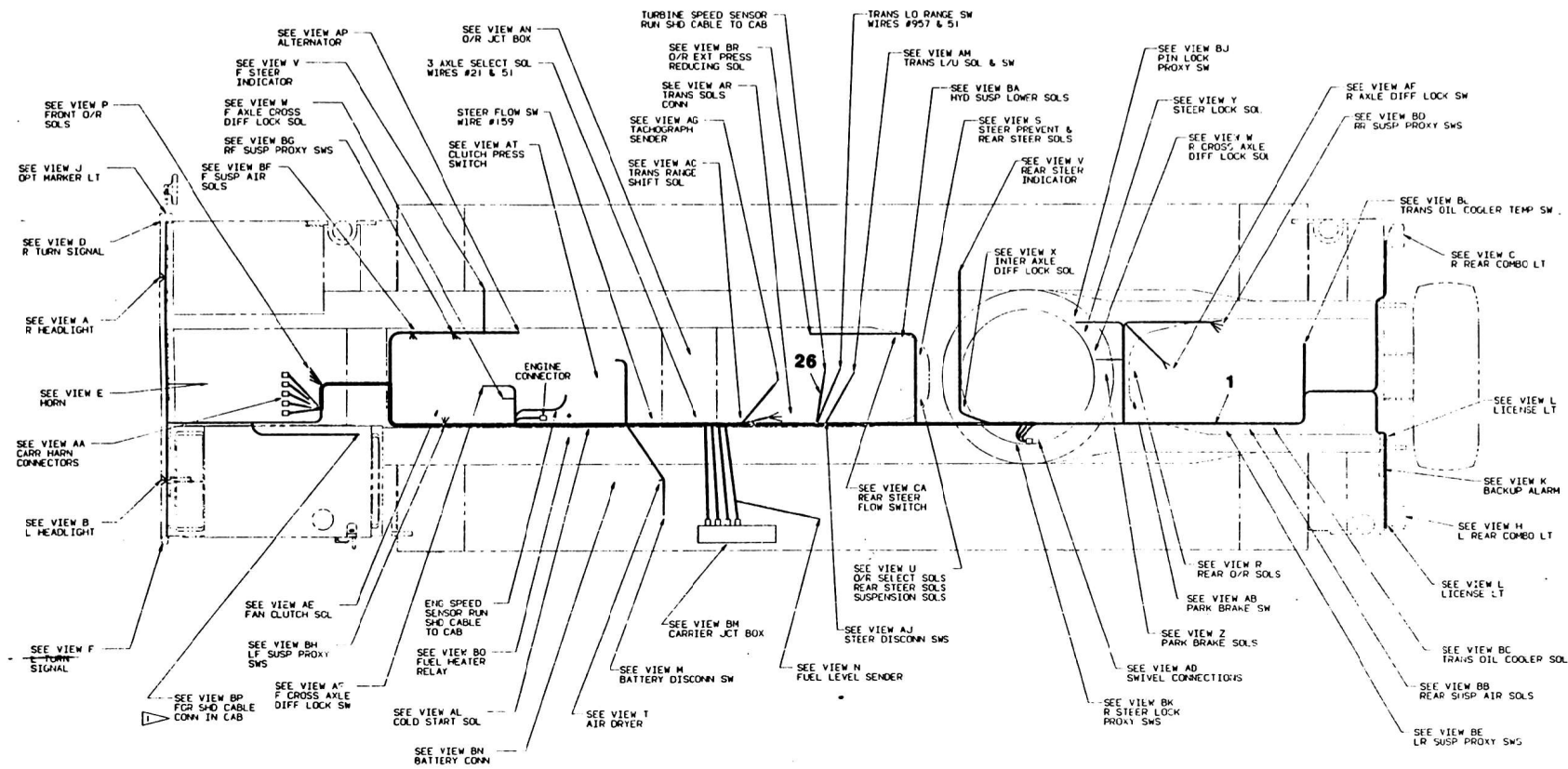

NOTE:
 ▲ APC-100 INSTL MUST BE CHECKED WITH SPEC A6-829-009851 BEFORE CONNECTING TO APC-100 UNIT

